











# LW Series / Linear Weigher 1 - 6 Lines

 304 Stainless Steel	 Capacity 5 L
 Modular System	 Speed 8 - 60 (*)
 IP- 65	 Power supply
 Hygienic Design	 Available
 Layout	 PLC Siemens

(\*) Depending on the number of lines and the type of product. This speed must be confirmed after the test.

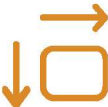

LW 01 C view ( 1 line model )

Solicitud ONLINE



Samples of packages



Front view ( 1 line model )



Side view

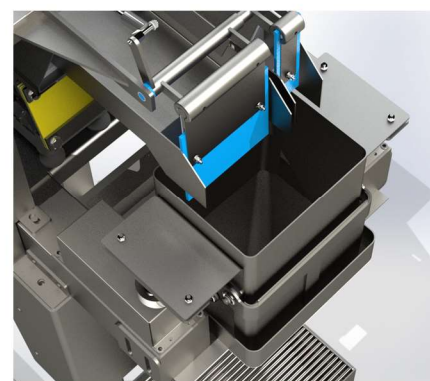

Detail view

The **SERMAX**® LM range of weighers has been designed for dosing by weight of up to 5 L in volume, improving hygiene and safety within the weighing environment and focusing on granulated products, maintaining at the same time, the high level of precision required. Key features include:

- ▶ Hygienic design
- ▶ Remote connection
- ▶ Direct unload to the package
- ▶ FDA components
- ▶ Mobile structure
- ▶ Overweight rejection
- ▶ Easy cleaning
- ▶ Offset distance between lines adjustable.
- ▶ Products mix